



IP Office Basic Edition

IP Office Basic Edition - Norstar Mode
9500 Series Phone User Guide

Notices

While reasonable efforts have been made to ensure that the information in this document is complete and accurate at the time of printing, Avaya assumes no liability for any errors. Avaya reserves the right to make changes and corrections to the information in this document without the obligation to notify any person or organization of such changes.

Documentation disclaimer

Avaya shall not be responsible for any modifications, additions, or deletions to the original published version of this documentation unless such modifications, additions, or deletions were performed by Avaya.

End User agree to indemnify and hold harmless Avaya, Avaya's agents, servants and employees against all claims, lawsuits, demands and judgments arising out of, or in connection with, subsequent modifications, additions or deletions to this documentation, to the extent made by End User.

Link disclaimer

Avaya is not responsible for the contents or reliability of any linked Web sites referenced within this site or documentation(s) provided by Avaya. Avaya is not responsible for the accuracy of any information, statement or content provided on these sites and does not necessarily endorse the products, services, or information described or offered within them. Avaya does not guarantee that these links will work all the time and has no control over the availability of the linked pages.

Warranty

Avaya provides a limited warranty on this product. Refer to your sales agreement to establish the terms of the limited warranty. In addition, Avaya's standard warranty language, as well as information regarding support for this product, while under warranty, is available to Avaya customers and other parties through the Avaya Support Web site: <http://www.avaya.com/support>. Please note that if you acquired the product from an authorized Avaya reseller outside of the United States and Canada, the warranty is provided to you by said Avaya reseller and not by Avaya.

Licenses

THE SOFTWARE LICENSE TERMS AVAILABLE ON THE AVAYA WEBSITE, [HTTP://SUPPORT.AVAYA.COM/LICENSEINFO/](http://support.avaya.com/licenseinfo/) ARE APPLICABLE TO ANYONE WHO DOWNLOADS, USES AND/OR INSTALLS AVAYA SOFTWARE, PURCHASED FROM AVAYA INC., ANY AVAYA AFFILIATE, OR AN AUTHORIZED AVAYA RESELLER (AS APPLICABLE) UNDER A COMMERCIAL AGREEMENT WITH AVAYA OR AN AUTHORIZED AVAYA RESELLER. UNLESS OTHERWISE AGREED TO BY AVAYA IN WRITING, AVAYA DOES NOT EXTEND THIS LICENSE IF THE SOFTWARE WAS OBTAINED FROM ANYONE OTHER THAN AVAYA, AN AVAYA AFFILIATE OR AN AVAYA AUTHORIZED RESELLER, AND AVAYA RESERVES THE RIGHT TO TAKE LEGAL ACTION AGAINST YOU AND ANYONE ELSE USING OR SELLING THE SOFTWARE WITHOUT A LICENSE. BY INSTALLING, DOWNLOADING OR USING THE SOFTWARE, OR AUTHORIZING OTHERS TO DO SO, YOU, ON BEHALF OF YOURSELF AND THE ENTITY FOR WHOM YOU ARE INSTALLING, DOWNLOADING OR USING THE SOFTWARE (HEREINAFTER REFERRED TO INTERCHANGEABLY AS "YOU" AND "END USER"), AGREE TO THESE TERMS AND CONDITIONS AND CREATE A BINDING CONTRACT BETWEEN YOU AND AVAYA INC. OR THE APPLICABLE AVAYA AFFILIATE ("AVAYA").

Avaya grants End User a license within the scope of the license types described below. The applicable number of licenses and units of capacity for which the license is granted will be one (1), unless a different number of licenses or units of capacity is specified in the Documentation or other materials available to End User. "Designated Processor" means a single stand-alone computing device. "Server" means a Designated Processor that hosts a software application to be accessed by multiple users. "Software" means the computer programs in object code, originally licensed by Avaya and ultimately utilized by End User, whether as stand-alone products or pre-installed on Hardware. "Hardware" means the standard hardware originally sold by Avaya and ultimately utilized by End User.

License types

Designated System(s) License (DS). End User may install and use each copy of the Software on only one Designated Processor, unless a different number of Designated Processors is indicated in the Documentation or other materials available to End User. Avaya may require the Designated Processor(s) to be identified by type, serial number, feature key, location or other specific designation, or to be provided by End User to Avaya through electronic means established by Avaya specifically for this purpose.

Copyright

Except where expressly stated otherwise, no use should be made of materials on this site, the Documentation(s) and Product(s) provided by Avaya. All content on this site, the documentation(s) and the product(s) provided by Avaya including the selection, arrangement and design of the content is owned either by Avaya or its licensors and is protected by copyright and other intellectual property laws including the sui generis rights relating to the protection of databases. You may not modify, copy, reproduce, republish, upload, post, transmit or distribute in any way any content, in whole or in part, including any code and software. Unauthorized reproduction, transmission, dissemination, storage, and or use without the express written consent of Avaya can be a criminal, as well as a civil, offense under the applicable law.

Third Party Components

Certain software programs or portions thereof included in the Product may contain software distributed under third party agreements ("Third Party Components"), which may contain terms that expand or limit rights to use certain portions of the Product ("Third Party Terms"). Information regarding distributed Linux OS source code (for those Products that have distributed the Linux OS source code), and identifying the copyright holders of the Third Party Components and the Third Party Terms that apply to them is available on the Avaya Support Web site: <http://support.avaya.com/Copyright>.

Preventing toll fraud

"Toll fraud" is the unauthorized use of your telecommunications system by an unauthorized party (for example, a person who is not a corporate employee, agent, subcontractor, or is not working on your company's behalf). Be aware that there can be a risk of toll fraud associated with your system and that, if toll fraud occurs, it can result in substantial additional charges for your telecommunications services.

Avaya fraud intervention

If you suspect that you are being victimized by toll fraud and you need technical assistance or support, call Technical Service Center Toll Fraud Intervention Hotline at +1-800-643-2353 for the United States and Canada. For additional support telephone numbers, see the Avaya Support Web site: <http://support.avaya.com>. Suspected security vulnerabilities with Avaya products should be reported to Avaya by sending mail to: securityalerts@avaya.com.

Trademarks

Avaya and Aura are trademarks of Avaya, Inc. The trademarks, logos and service marks ("Marks") displayed in this site, the documentation(s) and product(s) provided by Avaya are the registered or unregistered Marks of Avaya, its affiliates, or other third parties. Users are not permitted to use such Marks without prior written consent from Avaya or such third party which may own the Mark. Nothing contained in this site, the documentation(s) and product(s) should be construed as granting, by implication, estoppel, or otherwise, any license or right in and to the Marks without the express written permission of Avaya or the applicable third party. Avaya is a registered trademark of Avaya Inc. All non-Avaya trademarks are the property of their respective owners.

Downloading documents

For the most current versions of documentation, see the Avaya Support Web site: <http://www.avaya.com/support>

Contact Avaya Support

Avaya provides a telephone number for you to use to report problems or to ask questions about your product. The support telephone number is 1-800-242-2121 in the United States. For additional support telephone numbers, see the Avaya Web site: <http://www.avaya.com/support>

Contents

6.5 Deleting All Records.....	50
6.6 Adding a Record to Your Contacts.....	50
7. Button Programming	
7.1 Programming a Button.....	52
7.2 Changing a Button Label.....	53
7.3 Button Functions.....	54
8. Phone Settings	
8.1 Naming Your Extension.....	58
8.2 Visual Alerting.....	59
8.3 Audible Alerting.....	59
8.4 Ringer Sound.....	59
8.5 Ringer Volume.....	60
8.6 Display Brightness.....	60
8.7 Display Contrast.....	60
8.8 Display Language.....	60
8.9 Error Tones.....	61
8.10 Button Clicks.....	61
8.11 Default Handsfree Audio Path.....	61
8.12 The Admin Menu.....	62
8.13 The A MENU.....	63
8.14 A-Menu Auto Exit.....	64
Index.....	65
1. Introduction	
1.1 9500 Series 04 Telephones.....	8
1.2 9500 Series 08 Telephones.....	9
1.3 Dialing Codes.....	10
1.4 Feature Codes.....	11
2. Call Handling	
2.1 Making Calls.....	14
2.1.1 Making Internal Calls.....	14
2.1.2 Setting a Callback.....	14
2.1.3 Making External Calls.....	15
2.1.4 Making Page or Direct Calls.....	16
2.1.5 Redial.....	16
2.2 Answering Calls.....	17
2.2.1 Answer a Page Call.....	17
2.2.2 Call Pickup.....	18
2.3 Speed Dialing.....	19
2.3.1 System Speed Dials.....	19
2.3.2 Personal Speed Dials.....	20
2.3.3 Auto Dialing.....	21
2.4 Adjusting the Volume.....	22
2.5 Mute.....	22
2.6 Holding Calls.....	23
2.7 Parking Calls.....	23
2.8 Transferring Calls.....	24
2.8.1 Voice Mailbox Transfer.....	24
2.9 Conferencing Calls.....	25
2.10 Using Handsfree.....	26
2.11 Using a Headset.....	27
2.12 Joining Calls.....	27
3. Other Features	
3.1 Absent Text Messages.....	30
3.2 Forwarding Calls.....	31
3.3 Call Coverage.....	32
3.4 Locking Your Extension.....	34
3.5 Account Codes.....	35
3.6 Do Not Disturb.....	36
3.6.1 Do Not Disturb Exceptions.....	37
4. Using Voicemail	
4.1 Voicemail Coverage On/Off.....	41
5. Contacts	
5.1 Viewing Contacts Details.....	44
5.2 Make a Call from the Directory.....	45
5.3 Editing a Contact.....	45
5.4 Adding a New Contact.....	46
5.4.1 Add a Contact from the Call Log.....	46
5.5 Deleting a Contact.....	46
6. Call Log	
6.1 Using the Call Log.....	48
6.2 Making a Call from the Call Log.....	48
6.3 Viewing Call Details.....	49
6.4 Deleting a Record.....	50

Chapter 1.

Introduction

1. Introduction

This guide covers the basic operation of 9500 Series phones on a IP Office Basic Edition - Norstar Mode phone system.

Key System or PBX System

The IP Office Basic Edition - Norstar Mode system can operate in either of two modes; key mode or PBX mode. Your system administrator will confirm the mode being used by your system. The mode affects the order and role of some of the buttons on your phone.

Programmable Buttons

Each of the phones has a number of programmable buttons. The function of each such button is set either by the telephone system or by your system administrator or can be set by yourself. The role of the first few buttons is determined by whether your system is set to key system or PBX system mode.

Key System Mode

- **Intercom Buttons**

The first two programmable buttons are set as **Intercom** buttons and cannot be changed. These buttons are used to make and receive internal calls.

- **Line Appearance Buttons**

The next buttons are set as line buttons by your system administrator. These buttons are used to make and receive external calls. Your system administrator can adjust the number of line appearance buttons on your phone and which lines they represent.

- **Other Buttons**

Any remaining buttons can be programmed for a range of features. This is done by your system administrator or by yourself through the phone's menus. For more information refer to the IP Office Basic Edition - Norstar Mode Phone Base Administration manual.

PBX System Mode

- **Call Appearance Buttons**

For a system in PBX system mode, the first three programmable buttons are set call appearance buttons. These buttons are used to make and receive internal and external calls.

- **Line Appearance Buttons**

Your system administrator can assign the next buttons as line appearance buttons if required. This allows you to make and answer calls on a specific line if required.

- **Other Buttons**

Any remaining buttons can be programmed for a range of features. This is done by your system administrator or by yourself through the phone's menus. For more information refer to the IP Office Basic Edition - Norstar Mode Phone Base Administration manual.

1.1 9500 Series 04 Telephones

The programmable buttons are arranged in 2 pages of 4 to match the 4 physical buttons. The buttons are numbered from top-down, left to right on each page. The ◀ left arrow and right arrow ▶ buttons are used to switch between pages during normal operation.

The button numbering order on these phones does not depend on the system mode. However, the default button usage is affected by the system mode.

- For systems running in key system mode, the first two programmable buttons, 01 and 02, are fixed as **Intercom 1** and **Intercom 2** buttons.
- For systems running in PBX system mode, the first three buttons, 01 to 03, are fixed as call appearance buttons.

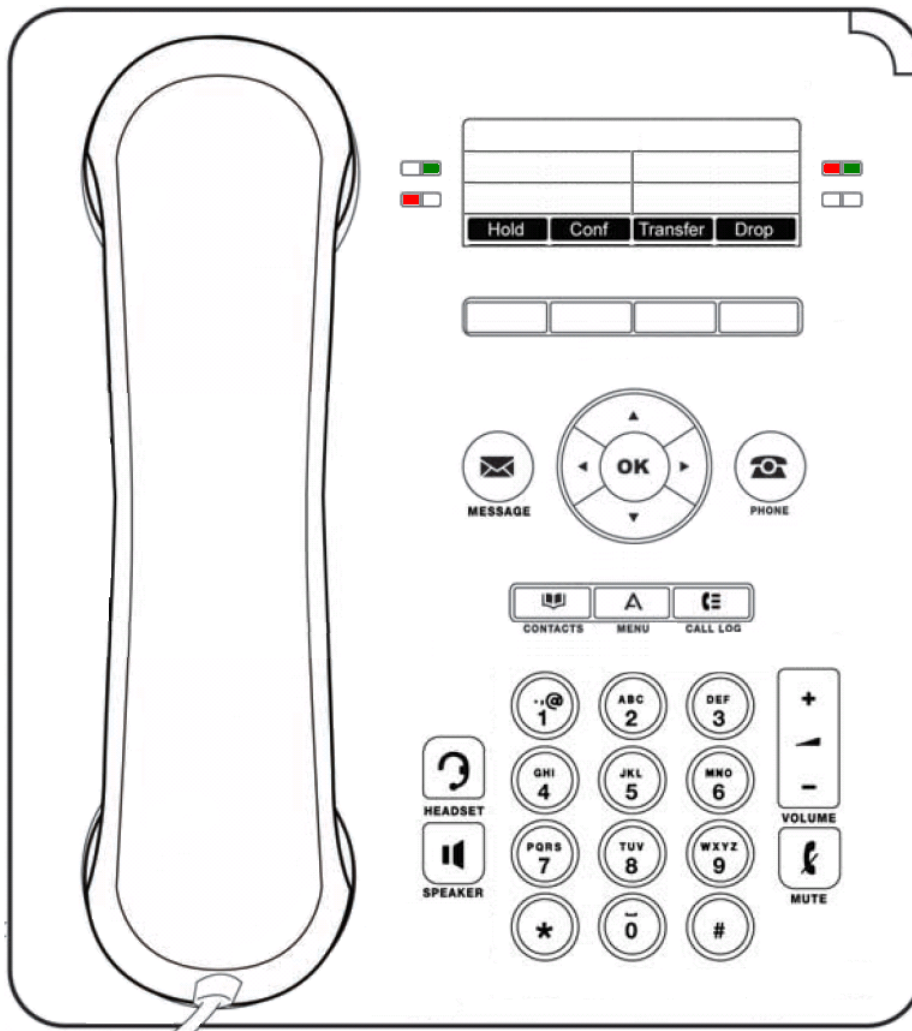

Page 1

01	03
02	04



Page 2

05	07
06	08

1.2 9500 Series 08 Telephones

The programmable buttons are arranged in 3 pages of 8 to match the 8 physical buttons. The buttons are numbered from top-down, left to right on each page. The ◀ left arrow and right arrow ▶ buttons are used to switch between pages during normal operation.

The button numbering order on these phones does not depend on the system mode. However, the default button usage is affected by the system mode.

- For systems running in key system mode, the first two programmable buttons, 01 and 02, are fixed as **Intercom 1** and **Intercom 2** buttons.
- For systems running in PBX system mode, the first three buttons, 01 to 03, are fixed as call appearance buttons.

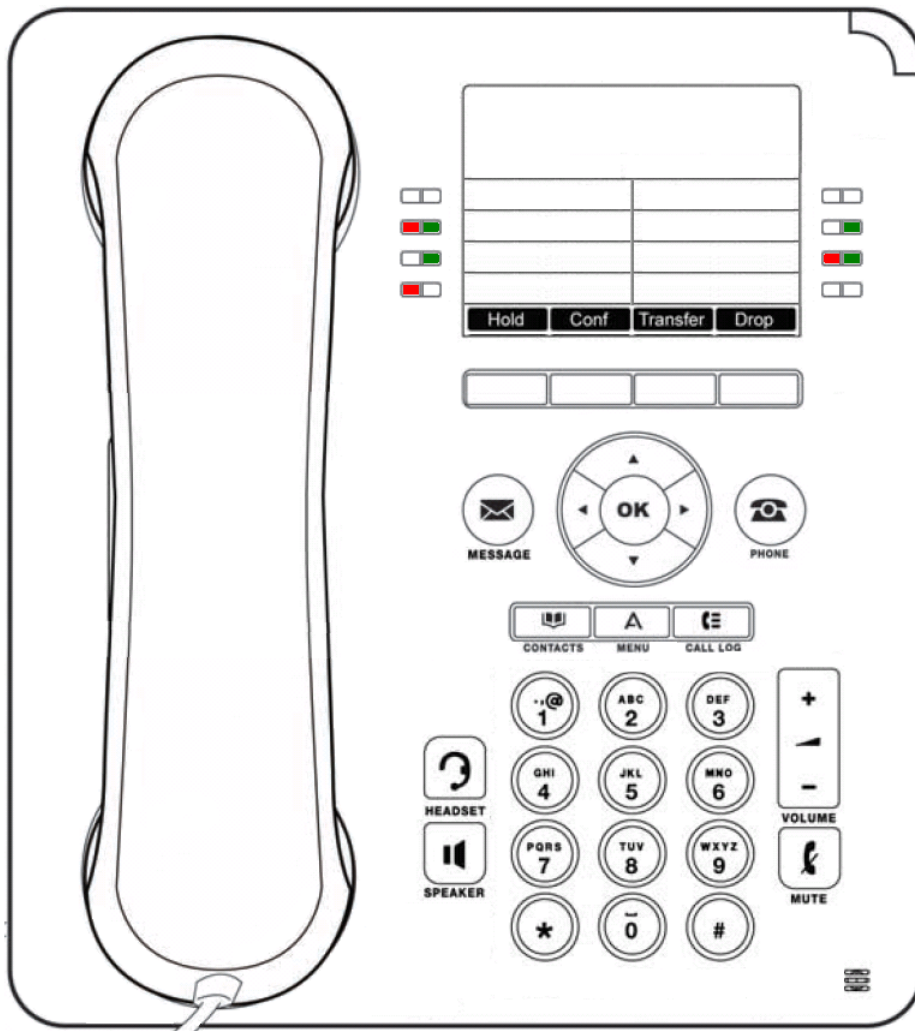

Page 1

01	05
02	06
03	07
04	08

Page 2

09	13
10	14
11	15
12	16

Page 3

17	21
18	22
19	23
20	24

1.3 Dialing Codes

The following features can be used by dialing the appropriate number.

Feature	Dial	Summary
Call Pickup	6 <Extension Number>	Answer the longest waiting call ringing at an extension.
Group Pickup	66 <Pickup Group>	Answer the longest waiting call ringing any extension that is a member of the pickup group (1 to 4) selected.
Idle Line Pickup	8 <Line Number>	Seize the specified line if it is idle and then make a call using that line.
Active Line Pickup	68 <Line Number>	Answer or seize the call on the specified line.
Loudspeaker Paging	70	Page the loudspeaker device attached to the system.
Simultaneous Paging	*70	Page both the loudspeaker device attached to the system and the extensions in calling group 71.
Group Calling – Ring	7 <Calling Group>	Call the available extensions in one of the calling groups (1 to 4).
Group Calling – Page	*7 <Calling Group>	Page the available extensions in one of the calling groups (1 to 4).
Group Hunting – Ring	77 <Hunt Group>	Call the available extensions in one of the hunt groups (1 to 6).
Group Hunting – Page	*77 <Hunt Group>	Page the first available extension in one of the hunt groups (1 to 6).

1.4 Feature Codes

The following feature codes can be dialed from most phones after pressing **Feature**. Most of these features can also be assigned to programmable buttons.

Feature	Code	Description
Do Not Disturb ³⁶	01	This function allows you to switch do not disturb on or off.
" Cancel ³⁶	01	
Recall	03	This function allows you to send a recall or hook flash signal.
Save Number Redial	04	This function allows you to save the number dialed during a call and to redial that number when idle. This can be used when the number dialed does not answer.
Last Number Redial ¹⁶	05	This function allows you to redial the last external number dialed.
Conference Drop ²⁵	06	This function allows you to select and drop a call from a conference.
Privacy ²⁷	07	This function allows you to turn privacy on or off. When on, other extensions are not able to bridge into your calls.
Call Forward ³¹	11	This function allows you to redirect all your calls to another number. If the system administrator has configured your for Remote Call Forwarding, you can forward calls externally by specifying a personal speed dial as the destination.
Call Forward Cancel ³¹	11	
Account Code Entry ³⁵	12	This function allows you to enter an account code prior to making a call or during a call.
Voice Mailbox Transfer ²⁴	14	This function allows you to transfer your current call to another extension's mailbox. Your current call is put on hold and you enter the target extension number to indicate the mailbox required.
VMS Cover ⁴¹	15	This function allows the you to switch use of voicemail coverage for your extension on or off.
Caller ID Name Display	16	This function allows you to swap the display of caller ID name and number information on the phone.
Caller ID Inspect	17	This function allows you to see the caller ID of a call on another line without interrupting the current call to which you are connected.
Call Coverage ³²	20	This function allows you to switch call coverage on or off. When on, any calls to you that ring unanswered also start ringing at your call coverage extension.
Station Lock ³⁴	21	This function allows you to lock and unlock your extension from being used to make calls. When selected, you are prompted to enter a four digit code after which the extension is locked. If the extension is already locked, use of this function prompts for reentry of the four digit code to unlock the extension.
Station Unlock ³⁴	22	This function can only be used by the first two extensions in the system. It allows the user to unlock any extension without needing to know the code that was used to lock that extension.
Caller ID Log	23	This function allows you to view the phone system's call log of all caller IDs of calls received by the system. To use this you must be one of the three extensions configured for call ID logging by your system administrator.
Hot Dial	26	This function allows you to dial a stored number without first going off hook or pressing the SPEAKER button.
Absent Message ³⁰	28	This function allows you to set or clear an absent message for display on you phone. When set, the absent message is also displayed on other extensions when they call the user.
Contact Closure 1	41	This function you to operate the system's contact closure 1 or 2 connection. To use this you must be a member of the system's contact closure group.
Contact Closure 2	42	
System Release	590	Displays the core software level that the system is running.
System IP Address	591	Displays the IP address of the systems LAN port.

Feature	Code	Description
SD Card Serial Number	592	Displays the feature key number of the System SD card. This is the number used for validation of licenses entered into the system configuration.
System Speed Dial ¹⁹	600 to 699	Dial the selected system speed dial number.
Personal Speed Dial ²⁰	80 to 99	Dial the selected personal speed dial number.
DND Exception Numbers ³⁶	700 to 719	Set a DND exception number.

Chapter 2.

Call Handling

2. Call Handling

2.1 Making Calls

2.1.1 Making Internal Calls

1. If already on a call, end the call by pressing **Drop** or put it [on hold](#)^[23] by either pressing **Hold** or pressing the button which the call is on.
2. Press an idle **Intercom** or **Call Appearance** button.
3. Dial the extension number or the code for the feature you wanted to access.

- **To call an extension:**
Dial the extension number. If you put a * in front of the extension number, the system will attempt to make a [direct voice call](#)^[16].
- **To call a group or attempt a call pickup:**
Dial one of the numbers in the table below. If you put a * in front of the group number, the system will make a [page call](#)^[16].

Feature	Dial	Summary
Loudspeaker Paging	70	Page the loudspeaker device attached to the system.
Simultaneous Paging	*70	Page both the loudspeaker device attached to the system and the extensions in calling group 71.
Group Calling – Ring	7 <Calling Group>	Call the available extensions in one of the calling groups (1 to 4).
Group Calling – Page	*7 <Calling Group>	Page the available extensions in one of the calling groups (1 to 4).
Group Hunting – Ring	77 <Hunt Group>	Call the available extensions in one of the hunt groups (1 to 6).
Group Hunting – Page	*77 <Hunt Group>	Page the first available extension in one of the hunt groups (1 to 6).

2. You will hear the call progress. You can continue the call handsfree or switch to using the handset or headset (press the **HEADSET** button).
 - If the other extension doesn't answer, press **AutCB** or **Callback** to have the system call you when that extension is next free.

2.1.2 Setting a Callback

If the call is to a user, and they do not answer, you can set a callback. When a callback is set, when the other user next uses their phone or ends their current call, the system will call you and when you answer, automatically makes another call to the user.

To Set a Callback

1. While the call is still ringing or if you hear busy. Press **Callback**.
2. End your call attempt by replacing the handset or pressing **Drop**.

To Clear a Callback

If you have a callback set, you can cancel it using the following process:

1. Press **Feature #2**.

2.1.3 Making External Calls

1. If already on a call, end the call by pressing **Drop** or put it [on hold](#)^[23] by either pressing **Hold** or pressing the button which the call is on.
2. Press an idle **Line Appearance** or **Call Appearance** button.
3. Dial the telephone number.
 - If using a **Call Appearance** button, some systems may require you to dialing a specific prefix when making external calls. Your system administrator will inform you if a prefix is required.
 - To dial a [personal speed dial](#)^[20], press **FEATURE** or # and select the speed dial between 80 and 89.
 - To dial a [system speed dial](#)^[19], press **FEATURE** or # and select a speed dial between 600 to 699.
 - To select a number from the directory press  **CONTACTS**.
4. You will hear the call progress. You can continue the call handsfree or switch to using the handset or headset (press the **HEADSET** button).

2.1.4 Making Page or Direct Calls

You can make calls that are automatically answered if the extension or extensions called support auto answer. There are two methods: page calls and direct voice calls, however the method for making both types of call is much the same.

To Make a Direct Voice Call

For a call to an individual extension, putting * in front of the extension number of the user being called makes the call a direct voice call. If supported by the phone being called, the call is automatically answered after the called users hears 3 beeps.

Unlike a page call, the called user can also speak without having to take any further action if their phone has a handsfree microphone. Otherwise they need to pickup the handset to be heard.

If the user called is already on a call when you attempt a direct voice call to them, your call is turned into a normal waiting call.

1. If already on a call, end the call by pressing **Drop** or put it on hold^[23] by either pressing **Hold** or pressing the button which the call is on.
2. Dial * and then the extension number of the user.
 - If the user's phone is idle and supports auto answer, you can speak and be heard by them immediately. You can also hear them.
 - If you hearing ringing, then either the user called already has another call in progress or has a phone that does not support answer.

To Make a Page Call

For a call to a group of extensions, putting a * in front of the extension number of the group being called make the call a page call. The group type is ignored, instead, all users who are members of the group, have phones that support auto answer and are currently not on another call, hear a single beep and can then hear you. However, you cannot hear the group members.

One of users being paged can answer the page^[17] if they want to. That turns the page call into a normal call between just you and the answering user.

2. If already on a call, end the call by pressing **Drop** or put it on hold^[23] by either pressing **Hold** or pressing the button which the call is on.
2. Dial * and then the extension number of the group.

To Page the Loudspeaker Device

The telephone system can include a connection to a loudspeaker paging device. To page this device make a normal internal call to the extension number 70. If you make an internal call to *70, you will page both the loudspeaker device and the available users in the calling group 71.

2.1.5 Redial

1. Press **Redial**. On 9500 Series phones, this is a display soft key on idle phones.
2. The display will show you your outgoing call log.
3. Use the ▲ up and down ▼ arrow keys to scroll through the records.
4. When the name or number required is shown, press **Call**.

2.2 Answering Calls

You can answer telephone calls that are ringing your extension or at another extension. If you regularly pick up calls for a specific extension you can program a [call pickup](#) ^[52] button for that specified extension.

1. If already on a call, end the call by pressing **Drop** or put it [on hold](#) ^[23] by either pressing **Hold** or pressing the button which the call is on.
2. While the call is alerting, additional options may be displayed.
 - **To VM**
This option sends the ringing call to voicemail to leave a message in your mailbox.
 - **Ignore**
This option does not affect the incoming calls but temporarily turns off the ringer.
 - **Drop**
This option can be used to end the call without answering it.
 - **Answer**
This option can be used to answer the call. The call is connected to either the speaker or headset depending on the phone's Default Handsfree Audio Path Setting.
3. If you pick up the handset or press **SPEAKER** or press **HEADSET**, you are connected to the incoming call.
 - To answer a call alerting on a specific line, press that button.

2.2.1 Answer a Page Call

There are two type of calls which your phone will automatically answer the call so that you automatically hear the caller. This will only happen if your phone is currently idle, ie. not on another call.

Three Beeps

A call connected automatically after [three beeps](#) is a direct voice call to your extension only.

1. The call is connected and answered automatically. You can speak to the caller without taking any further action.

Single Beep

A call connected automatically after [a single beep](#) is a page call a group of which your phone is a member. You can hear the caller but they cannot hear you.









1. You can answer the call, turning it into a normal call between just you and the caller. Press **Answer**. You can continue handsfree or pickup the handset.

2.2.2 Call Pickup

If you hear another phone ringing, there are a number of ways that you can answer the call if you know the user, group or line being called.

1. If already on a call, end the call by pressing **Drop** or put it [on hold](#) ^[23] by either pressing **Hold** or pressing the button which the call is on.
2. Press an idle **Intercom** or **Call Appearance** button.
 - **To pickup a call ringing at a particular extension:**
Dial **6** followed by the extension number at which the call is ringing or parked.
 - **To pickup the longest waiting call in a pickup group:**
Dial **66** followed by the pickup group number (1 to 4).
 - **To pickup the call ringing on a particular line:**
Dial **68** followed by the two digit line number.
3. You can continue the call handsfree or switch to using the handset or headset (press the **HEADSET** button).

To Create a Call Pickup Button

1. Press the **Admin** soft key on the display.
 - During a call, press the  **PHONE** button to display the **Admin** soft key option. If you access phone administration during a call, only the **SPEAKER**, **MUTE** and **HEADSET** buttons still affect the connected call.
2. Use the  up or down  arrow buttons to scroll to **Telephone Programming**. Press **Select**.
3. Press the programmable button you want to change. Alternatively:
 - Use the  up or down  arrows to scroll to **Button Programming**. Press **Select**.
 - At the **Button:** prompt press the button to edit or enter from the button number.
4. The current setting of that button is displayed.
5. Press **Program** and either press **Intercom 1** or use the  up or down  arrow buttons to scroll the display to **Call Pickup** and press **Select**.
6. At the **Endpoint:** prompt enter **6** followed by the target extension.
7. The current setting of the button will now be **Call Pickup** followed by the target extension number.
 - Exit phone administration by pressing the  **PHONE** button. Alternatively use the **Back** button to move to another menu.

To Use a Call Pickup Button



1. Press the **Call Pickup** programmed button for the specified extension number. You are connected to the call that was ringing the specified extension.

2.3 Speed Dialing

There are a number of ways that you can dial a stored number.

2.3.1 System Speed Dials

The system administrator can program up to 100 frequently used number as system speed dial numbers 600 to 699. Any user in the system can use a system speed dial by pressing **FEATURE** and dialing the three digit code of the system speed dial required.

- Except in special cases which the system administrator can configure, system speed dials do not override any dialing restrictions that apply to an extension.
- Phone users can also view and use system speed dials through the phone's  **CONTACTS**  menu.
- The first two extensions on the system can also edit the system speed dials through the  **CONTACTS** menu.



To Use a System Speed Dial

1. If already on a call, end the call by pressing **Drop** or put it [on hold](#)  by either pressing **Hold** or pressing the button which the call is on.
2. Press **FEATURE** or # and dial the three digit system speed dial code between 600 and 699.
3. The stored number is dialed.

2.3.2 Personal Speed Dials

You can create up to 20 personal speed dial codes, 80 to 99, to store frequently dialed numbers. The numbers can be quickly dialed by pressing **FEATURE** and the two-digit code for that personal speed dial.





The personal speed dial numbers programmed for a particular extension can only be used at that extension.

- If the system is connected to a PBX or Centrex system and a dial-out code (usually 9) is needed to place calls outside the PBX or Centrex system, include the dial-out code in Speed Dial numbers that must dial out of the PBX or Centrex system.
- Personal speed dials do not override any dialing restrictions that apply to an extension.
- Phone users can view, use and edit their personal speed dials through the phone's  **CONTACTS**  menu.

To Use a Personal Speed Dial

1. If already on a call, end the call by pressing **Drop** or put it on hold  by either pressing **Hold** or pressing the button which the call is on.
2. Press **FEATURE** or # and dial the two digit personal speed dial code between 80 and 99.
3. The stored number is dialed.

To Edit Your Personal Speed Dials

1. Press the **Admin** soft key on the display.
 - During a call, press the  **PHONE** button to display the **Admin** soft key option. If you access phone administration during a call, only the **SPEAKER**, **MUTE** and **HEADSET** buttons still affect the connected call.
2. Use the  up or down  arrow buttons to scroll to **Telephone Programming**. Press **Select**.
3. Use the  up or down  arrow buttons to scroll the display to **Personal Speed Dial**. When displayed, press **Select**.
4. At the **Code:** prompt enter between 80 and 99 to select the speed dial entry that you want to edit.
5. The current setting of the speed dial entry is displayed.
6. To enter a number press **Enter**, dial the number and press **Enter**. To remove the number press **Clear**.
 - The number can be up to 28 characters in length.
 - If your system uses an external dialing prefix, remember to include the prefix.
 - These options are accessed by pressing **More** and then selecting **Pause**, **Stop** or **Recall** as required.

Function	Character	Description
Pause	P	Inserts a 1.5 second pause.
Recall	R	Send a hook-switch flash signal.
Stop	S	Stop dialing.

- Exit phone administration by pressing the  **PHONE** button. Alternatively use the **Back** button to move to another menu.











2.3.3 Auto Dialing

An auto dialing button is used to store a frequently used or important number. Whenever the number needs to be dialed, pressing the button will dial the stored number.

To Use an Auto Dial Button

1. At dial tone or whenever you want to dial a number, press the programmed auto dial button.
2. The stored number is dialed.

To Create an Auto Dial - Other Button

1. Press the **Admin** soft key on the display.
 - During a call, press the  **PHONE** button to display the **Admin** soft key option. If you access phone administration during a call, only the  **SPEAKER**,  **MUTE** and  **HEADSET** buttons still affect the connected call.
2. Use the  up or down  arrow buttons to scroll to **Telephone Programming**. Press **Select**.
3. Press the programmable button you want to change. Alternatively:
 - Use the  up or down  arrows to scroll to **Button Programming**. Press **Select**.
 - At the **Button:** prompt press the button to edit or enter from the button number.
4. The current setting of that button is displayed.
5. Press **Program** and either press **Intercom 2** or use the  up or down  arrow buttons to scroll the display to **Auto Dial - Other** and press **Select**.
6. At the **AD-O:** prompt enter the number for calls made using the button. The number can include * and # and the following special characters:
 - These options are accessed by pressing **More** and then selecting **Pause**, **Stop** or **Recall** as required.

Function	Character	Description
Pause	P	Inserts a 1.5 second pause.
Recall	R	Send a hook-switch flash signal.
Stop	S	Stop dialing.

7. The current setting of the button will now be **AD-O** followed by the stored number.
8. To remove the current setting press **Clear**.
 - Exit phone administration by pressing the  **PHONE** button. Alternatively use the **Back** button to move to another menu.

2.4 Adjusting the Volume

While the phone is connected to a call you can adjust the volume. The volume that gets adjusted will depend on whether you are using the handset, speakerphone or headset at the time you use this process.

1. Use the ▲ up arrow and ▼ down arrow keys to change the volume.

2.5 Mute

While on a call, you can temporarily turn off the microphone so that the caller cannot hear you. You however will still be able to hear the caller.

To mute the microphone press the  **Mute** key. While mute is active, the button is lit.

2.6 Holding Calls

When you put a call on hold, you can make and receive other calls. However, if a call is left on hold for too long, by default 15 seconds, it will automatically alert your phone again if you are not on another call.

To Put a Call on Hold

1. During the call, either press the **HOLD** button or press the button on which the call is taking place. The **Green** light next to the button will change to fast flashing green to show there is a call on hold.

To Return to a Call Put on Hold

1. If already on a call, end the call by pressing **Drop** or put it [on hold](#) ^[23] by either pressing **Hold** or pressing the button which the call is on.
2. Press the button next to the fast flashing **Green** light. You are connected to the call. The light changes to steady.

2.7 Parking Calls

Use this feature to place a call on a special type of hold where it can be retrieved from any extension in the system.

- You should park only one call at a time to ensure that you know which caller you are talking to when you retrieve the parked call.
- If you frequently park calls, program your extension number on an [Auto Dial](#) ^[21] button, so you can park a call simply by pressing that button during the park process.

To Park a Call

1. While on a call, press **TRANSFER** and dial your own extension number.
2. Hang up. If the call is not picked up within three minutes, it rings back at your extension.

To Retrieve a Parked Call

1. Press an **Intercom** or **Call Appearance** button and **6** followed by the extension number of the extension that parked the call.

2.8 Transferring Calls

You can transfer a call to another extension.

1. While the call is active, press **TRANSFER**. The call is put on hold and the green light next to the button flashes rapidly.
2. Make a call to the transfer destination. Then do one of the following:
 - To transfer the call without announcing it (an unsupervised or blind transfer) hang up or press the **Transfer** button again. You can do this as soon as you hear ringing. The transfer is complete. If the call is not answered it will be returned to your extension. When your extension rings, lift the handset to be reconnected to the caller.
 - To announce the call before completing the transfer (a supervised transfer), wait for the call to be answered. If the called party is willing to accept the call hang up or press **Transfer** again. If no one answers or the call is refused, press the button next to the fast flashing green light to be reconnected to the original caller.

2.8.1 Voice Mailbox Transfer

You can transfer a caller to directly to an extension's voice mailbox for the caller to leave a message without first ringing the extension. This feature is useful when you know that the extension user is not present and has not set do not disturb.

You can program a voice mailbox transfer button to transfer a caller directly to a voice mailbox by pressing the button and then dialing the mailbox subscriber's extension number.

To Transfer a Caller to an Extensions Mailbox

1. During the call press **FEATURE 14** or press a **Voice Mailbox Transfer** button you have one programmed.
2. Dial the two digit extension number of the extension for which the caller wants to leave a message. The caller is routed to the mailbox and hears the recorded greeting for that mailbox.
3. Hang up.

To Create a Voice Mailbox Transfer Button

1. Press the **Admin** soft key on the display.
 - During a call, press the  **PHONE** button to display the **Admin** soft key option. If you access phone administration during a call, only the **SPEAKER**, **MUTE** and **HEADSET** buttons still affect the connected call.
2. Use the  up or down  arrow buttons to scroll to **Telephone Programming**. Press **Select**.
3. Press the programmable button you want to change. Alternatively:
 - Use the  up or down  arrows to scroll to **Button Programming**. Press **Select**.
 - At the **Button:** prompt press the button to edit or enter from the button number.
4. The current setting of that button is displayed.
5. Press **Program** and either dial **#14** or use the  up or down  arrow buttons to scroll the display to **Voice Mailbox Transfer** and press **Select**.
6. The current setting of the button will now be set to **Voice Mailbox Transfer**.
 - Exit phone administration by pressing the  **PHONE** button. Alternatively use the **Back** button to move to another menu.

2.9 Conferencing Calls

The Conference feature allows you to conference other parties (including yourself) into a call. The system supports multiple conferences of up to 64 parties in total, including up to 2 external analog trunk in each conference.

To Create a Conference Call

1. While active on a call, press **CONF**. The first party is now on hold.
2. When you hear dial tone, dial the telephone number of the second party.
3. When the call is answered, press **CONF** again. The second party is added to the call the call. All parties hear a single beep to indicate that they are in a conference call.
4. You can now speak to the first and second parties.
5. Repeat step 2 to add more parties.

To Hold a Conference Call

If you need to answer or make another call during a conference, you can [hold](#)  in the same way as for normal calls. When you put a conference call on hold, the other parties can still talk to each other.

- **! WARNING**

Only hold a conference that you know is taking place on your own telephone system. If you hold a conference that you have joined on another telephone system, that conference will hear hold music.

1. Press the **HOLD** button. The **Green** light next to the button will fast flash to show that the call is on hold.
2. To re-join the conference call press the button next to the **Green** light. You will rejoin the conference.

To Drop Other Parties from the Call

1. While in the conference, press **Details**.
2. Scroll through the parties in the conference.
3. When the party you want to drop is shown, press **Drop**.

To Mute Other Parties

1. While in the conference, press **Details**.
2. Scroll through the parties in the conference.
3. When the party you want to drop is shown, press **Drop**.

To Remove Yourself from a Conference Call

1. While in the conference call, press **Drop** twice.
2. The remaining parties on the conference hear a double beep.
3. The remaining parties on the conference can still talk to each other. When only one party remains on the call, the call is disconnected.

2.10 Using Handsfree

The telephone has a speaker and microphone which you can control using the **SPEAKER** button.

- To make and answer calls handsfree, use the **SPEAKER** button in the same way as lifting or replacing the handset. The button is lit while the phone is in handsfree mode.
- When you make or answer calls by first pressing an **Intercom**, **Call Appearance** or **Line Appearance** button, the call is automatically connected either on the speaker or headset. Which is used is set by the phone's [Default Hands Audio Path](#) setting.
- If already using the handset, you can switch to handsfree by pressing **SPEAKER**. You can then replace the handset.
- If already connected to a call handsfree, lifting the handset will end the handsfree.



Note

Room acoustics and background noise can affect the proper operation of the speakerphone. To ensure that your speakerphone works effectively, follow these guidelines:

- Avoid placing your telephone in areas with high background noise caused by sources such as motor vehicles, manufacturing equipment, loud voices, radios, printers, copiers, typewriters, other noisy office equipment or heater and air conditioning fans.
- Avoid talking before the other person is finished speaking. When you both talk at the same time, only one person's voice comes through.
- Do not use your speaker to make announcements over a loudspeaker paging system connected to your telephone system.
- When talking, always face your telephone and stay within two feet of it.
- Place your telephone at least six inches (15 cm) away from the edge of your desk.
- If you have difficulty hearing the other party, try increasing the speaker volume. If you have background noise, try turning off the microphone when the party at the other end is speaking and turning it on when you speak. If the difficulty persists, lift your handset to continue the conversation.
- In conference rooms, a separate speakerphone is recommended, since the built-in speaker on a system telephone is designed for individual use.

2.11 Using a Headset

The telephone has a headset socket which you can control using the  **HEADSET** button.

- To make and answer calls on the headset, use the  **HEADSET** button in the same way as lifting or replacing the handset. The button is lit while the phone is in headset mode.
 - **Remaining in Headset Mode**
If you use the **DROP** key to end a headset call, the phone will remain in headset mode. New calls will alert on the headset. You can use the **Intercom**, **Call Appearance**, **Line Appearance** and **Drop** buttons to make and answer calls while remaining in headset mode.
- If not already in headset mode, when you make or answer calls by first pressing an **Intercom**, **Call Appearance** or **Line Appearance** button, the call is automatically connected either on the speaker or headset. Which is used is set by the phone's [Default Hands Audio Path](#)  setting.
- If already using the handset, you can switch to headset by pressing  **HEADSET**. You can then replace the handset.

2.12 Joining Calls

Joining is adding yourself to a call in progress.

- **You cannot:**
 - Join an internal call or a conference call at another extension.
 - Join a call at any extension where the extension user has privacy enabled.
 - Put a joined call on hold.
- **You can:**
 - Tell when someone has joined your call when you hear a single beep.
 - Use privacy to allow or prevent others from joining your calls.
 - Join a call that is being answered by the voice messaging system. When you join the call, the voice messaging system disconnects automatically so you can speak to the caller.
 - Dial 68 <Line Number> to join a call on that line if a line is not assigned to a button on your extension.

To Join a Call

A steady red light next to a line button indicates that a call is in progress on that line.

1. If already on a call, end the call by pressing **Drop** or put it [on hold](#)  by either pressing **Hold** or pressing the button which the call is on.
2. Press the line button next to the steady red light and lift the handset. Alternatively, press and **Intercom** or **Call Appearance** button and dial **68** followed by the two-digit line number.
3. You are now joined with the call. All parties on the call hear a single beep.

To Switch Privacy On or Off

You can use the privacy feature to stop people joining your current call. You can either assign the function to a programmable button or you can dial **Feature 07** to turn privacy on or off.

Chapter 3.

Other Features

3. Other Features

3.1 Absent Text Messages

The absent text message feature assists internal callers by displaying a message on their telephone. When another extension calls your extension, your active absent text message appears on the caller's display.

To set and clear an absent text message you need to assign the feature to a programmable button with lights. The button can then be used to activate, select and deactivate the message.

To Create an Absent Message Button

1. Press the **Admin** soft key on the display.
 - During a call, press the  **PHONE** button to display the **Admin** soft key option. If you access phone administration during a call, only the  **SPEAKER**,  **MUTE** and  **HEADSET** buttons still affect the connected call.
2. Use the ▲ up or down ▼ arrow buttons to scroll to **Telephone Programming**. Press **Select**.
3. Press the programmable button you want to change. Alternatively:
 - Use the ▲ up or down ▼ arrows to scroll to **Button Programming**. Press **Select**.
 - At the **Button:** prompt press the button to edit or enter from the button number.
4. The current setting of that button is displayed.
5. Press **Program** and either dial **#28** or use the ▲ up or down ▼ arrow buttons to scroll the display to **Absent Message** and press **Select**.
6. The current setting of the button will now be set to **Absent Message**.
 - Exit phone administration by pressing the  **PHONE** button. Alternatively use the **Back** button to move to another menu.

To Activate an Absent Text Message

1. Press the absent text message button. The first absent text message is displayed.
2. Scroll through the default messages by pressing the button beneath the word **Next** until the required message is displayed.

<ul style="list-style-type: none">• Back soon• Do not disturb• Out to lunch• Away from desk	<ul style="list-style-type: none">• Please Call• At lunch until• Don't disturb until• With cust.til	<ul style="list-style-type: none">• Back tomorrow• On Vacation• At home• Be right back	<ul style="list-style-type: none">• On Holiday until• Meeting until• With visitors until
--	--	---	--

3. Press the button beneath the word **Activ** to select the message shown on the display.
4. To add additional text or edit the existing text, press **More** and then **Edit**.
5. To complete the process press the absent text message button again.

To Deactivate the Absent Text Message

1. Press the absent text message button.
2. Press the button beneath the word **Dactiv**.
3. To complete the process press the absent text message button again.

3.2 Forwarding Calls

All external, internal and transferred calls directed to your extension can be diverted to a different internal extension number. You can enter the destination extension telephone number and select when calls are redirected using a programmed button.

Before you can automatically forward calls you need to assign the feature to a button with lights. The button can then be used to turn call forwarding on and off as required.

- Selected users may also be able to do remote call forwarding where they forward their calls to an external number. If that is the case, consult your system administrator, you can use your [personal speed dials](#) ^[20] as the forwarding destination.
- You receive a slow interrupted intercom dialling tone when call forwarding is active.



To Manually Set Forwarding

1. Press **FEATURE 11**.
2. Enter the number to which you want to forward calls.
 - Exit phone administration by pressing the  **PHONE** button. Alternatively use the **Back** button to move to another menu.

To Manually Cancel Forwarding

1. Press **FEATURE 11**.
2. Enter you own extension number as the destination.
 - Exit phone administration by pressing the  **PHONE** button. Alternatively use the **Back** button to move to another menu.

To Create a Call Forwarding Button

1. Press the **Admin** soft key on the display.
 - During a call, press the  **PHONE** button to display the **Admin** soft key option. If you access phone administration during a call, only the **SPEAKER**, **MUTE** and **HEADSET** buttons still affect the connected call.
2. Use the ▲ up or down ▼ arrow buttons to scroll to **Telephone Programming**. Press **Select**.
3. Press the programmable button you want to change. Alternatively:
 - Use the ▲ up or down ▼ arrows to scroll to **Button Programming**. Press **Select**.
 - At the **Button:** prompt press the button to edit or enter from the button number.
4. The current setting of that button is displayed.
5. Press **Program** and either dial **#11** or use the ▲ up or down ▼ arrow buttons to scroll the display to **Call Forwarding** and press **Select**.
6. At the **Call Coverage Orig:** prompt enter the extension number for which the button is being programmed.
7. At the **Call Coverage Dest:** prompt enter the destination extension number for the call coverage calls.
 - To forward to an external number, enter the personal speed dial (80 to 99) that contains the required external number.
8. The current setting of the button will now be set to **Call Forward O <covered extension> D <destination extension>**.
 - Exit phone administration by pressing the  **PHONE** button. Alternatively use the **Back** button to move to another menu.

3.3 Call Coverage

Call coverage is used to redirect all intercom, transferred, DID and outside calls on lines assigned to you to another extension. When call coverage is in use, covered calls are routed to the covering extension after a specified number of rings set by the system administrator.

- Group calls, forwarded calls, transfer-return calls and calls to doorphone alert extensions are not covered.
- A single extension can cover multiple extensions, however an extension can have only one covering extension.
- If you activate call coverage at your extension, for calls on a line appearance button, you still can intercept a call rerouted to coverage by pressing the button.
- You can program call coverage on a programmable button. Use a button with lights if you want a visual indication when your calls are being covered. When the button indicator is on, your calls are being covered; when off, call coverage is not active.
- If both call coverage and do not disturb are on, covered calls go immediately to the covering extension without ringing the covered extension. Similarly, if call coverage is on and a call begins to ring, you can turn on [Do Not Disturb](#) ^[36] to send that call immediately for coverage.
- If an extension has call coverage and [VMS Cover](#) ^[41] active, calls ring at the covering extension.
 - If the covering extension does not answer, the call is routed to the voice mailbox of the covered extension after the specified number of VMS Cover Rings. If the covering extension has [Do Not Disturb](#) ^[36] active, the call is routed immediately to voicemail.
- If an extension has call coverage active without voice mail coverage, covered calls ring at the covering extension for the specified number of call coverage rings. Outside and intercom calls continue to ring at the covering extension until the call is answered or the caller hangs up.
- For transferred calls, if the covering extension does not answer, the call goes to the transfer return extension after the specified number of Transfer Return Rings (if VMS cover is not active).
- Call forwarding override call coverage. If an extension has call coverage and call forwarding active, calls are routed to the call forwarding destination extension.

To Send Calls to Coverage

1. Press **FEATURE 20**.
2. Dial the extension number of the covering extension.

To Remove Call Coverage

1. Press **FEATURE 20**.
2. Dial your own extension number.

To Create a Call Coverage Button

1. Press the **Admin** soft key on the display.

- During a call, press the  **PHONE** button to display the **Admin** soft key option. If you access phone administration during a call, only the **SPEAKER**, **MUTE** and **HEADSET** buttons still affect the connected call.

2. Use the ▲ up or down ▼ arrow buttons to scroll to **Telephone Programming**. Press **Select**.

3. Press the programmable button you want to change. Alternatively:

- Use the ▲ up or down ▼ arrows to scroll to **Button Programming**. Press **Select**.
- At the **Button:** prompt press the button to edit or enter from the button number.

4. The current setting of that button is displayed.

5. Press **Program** and either dial **#20** or use the ▲ up or down ▼ arrow buttons to scroll the display to **Call Coverage** and press **Select**.

6. At the **Call Coverage Orig:** prompt enter the extension number for which the button is being programmed.

7. At the **Call Coverage Dest:** prompt enter the destination extension number for the call coverage calls.

8. The current setting of the button will now be set to **Call Coverage O <covered extension> D <destination extension>**.

- Exit phone administration by pressing the  **PHONE** button. Alternatively use the **Back** button to move to another menu.

To Use a Call Coverage Button

1. Press the programmed button. When on, if programmed on a button with a light, the light will be on.

3.4 Locking Your Extension

You can use the lock feature to prevent unauthorized people from making outside calls from your extension while you are away from the extension. The user of the first extension on the system can unlock extensions without needing to know the code used to lock the phone. They can do this using **FEATURE 22**.









To Lock Your Extension

1. Press **FEATURE 21**.
2. Dial a four digit code using the 0 to 9 numbers .
3. Redial the four digit code.

To Unlock Your Extension

1. Press **FEATURE 21**.
2. Dial the four digit code you used to lock the extension.

To Create a Station Lock Button

1. Press the **Admin** soft key on the display.
 - During a call, press the  **PHONE** button to display the **Admin** soft key option. If you access phone administration during a call, only the **SPEAKER**, **MUTE** and **HEADSET** buttons still affect the connected call.
2. Use the  up or down  arrow buttons to scroll to **Telephone Programming**. Press **Select**.
3. Press the programmable button you want to change. Alternatively:
 - Use the  up or down  arrows to scroll to **Button Programming**. Press **Select**.
 - At the **Button:** prompt press the button to edit or enter from the button number.
4. The current setting of that button is displayed.
5. Press **Program** and either dial **#21** or use the  up or down  arrow buttons to scroll the display to **Station Lock** and press **Select**.
 - The first two extensions on the system can also assign the function Station Unlock to a button for use to unlock other extensions.
- Exit phone administration by pressing the  **PHONE** button. Alternatively use the **Back** button to move to another menu.

3.5 Account Codes

An account code is typically used to identify a department, project, or client for charge-back or tracking purposes. An account code can be either forced or optional. When an extension is set up with the forced account code feature, the user must enter an account code before they can dial outside calls







To Manually Enter an Account Code

1. After lifting the handset (or while already active on an outside call), press **FEATURE** and dial **12**.
2. Enter an account code by dialing the account code using the telephone's dial pad.
3. Press **Done**.
4. Continue with the call.

To Use an Account Code Button

1. After lifting the handset or while already active on an outside call, press the **Account Code Entry** button.
2. Enter an account code using the telephone's dial pad. Press the **Account Code Entry** button again or press the **Done** button.
3. Continue with the call.

To Create an Account Code Entry Button

1. Press the **Admin** soft key on the display.
 - During a call, press the  **PHONE** button to display the **Admin** soft key option. If you access phone administration during a call, only the  **SPEAKER**,  **MUTE** and  **HEADSET** buttons still affect the connected call.
2. Use the  up or down  arrow buttons to scroll to **Telephone Programming**. Press **Select**.
3. Press the programmable button you want to change. Alternatively:
 - Use the  up or down  arrows to scroll to **Button Programming**. Press **Select**.
 - At the **Button:** prompt press the button to edit or enter from the button number.
4. The current setting of that button is displayed.
5. Press **Program** and either dial **#12** or use the  up or down  arrow buttons to scroll the display to **Account Code Entry** and press **Select**.
6. The current setting of the button will now be set to **Account Code Entry**.
 - Exit phone administration by pressing the  **PHONE** button. Alternatively use the **Back** button to move to another menu.

3.6 Do Not Disturb

Use this feature to be able to press a programmed button to prevent incoming calls for the extension from ringing (lights may still flash). You can still use the extension to make calls and to answer calls using line appearance buttons.

-
- Use Do Not Disturb when you do not want the auto attendant or the voice messaging system to transfer calls to you.
- If you are assigned to a hunt group and you leave your desk, use Do Not Disturb so that calls to the hunt group will skip your extension and ring immediately at the next available extension in the group.
- Unanswered calls that are transferred from an extension with Do Not Disturb active, ring at that extension if they transfer return.
- If you have [VMS Cover](#)^[41] turned on, enabling Do Not Disturb will send all your calls immediately to your voicemail mailbox.
- If you have [Call Coverage](#)^[32] turned on, enabling Do Not Disturb will send all your calls immediately to the covering extension.
- An **N** is shown on your phone's idle display when you have Do Not Disturb enabled. If you go off-hook, you will hear interrupted dial tone.

To Manually Switch Do Not Disturb On/Off

1. Dial **FEATURE 01**. An **N** is shown on your phone's idle display when you have do not disturb enabled.









To Create a Do Not Disturb Button

When Do Not Disturb feature is on, the button's light is lit.

1. Press the **Admin** soft key on the display.
 - During a call, press the  **PHONE** button to display the **Admin** soft key option. If you access phone administration during a call, only the **SPEAKER**, **MUTE** and **HEADSET** buttons still affect the connected call.
2. Use the ▲ up or down ▼ arrow buttons to scroll to **Telephone Programming**. Press **Select**.
3. Press the programmable button you want to change. Alternatively:
 - Use the ▲ up or down ▼ arrows to scroll to **Button Programming**. Press **Select**.
 - At the **Button:** prompt press the button to edit or enter from the button number.
4. The current setting of that button is displayed.
5. Press **Program** and either dial **#01** or use the ▲ up or down ▼ arrow buttons to scroll the display to **Do Not Disturb** and press **Select**.
6. The current setting of the button will now be set to **Do Not Disturb**.
 - Exit phone administration by pressing the  **PHONE** button. Alternatively use the **Back** button to move to another menu.

3.6.1 Do Not Disturb Exceptions

You can create a set of up to 20 numbers, calls from which are able to still ring you even when you have do not disturb switched on. You can include wildcards in the number in order to create an exception for a range of numbers.

1. Press the **Admin** soft key on the display.
 - During a call, press the  **PHONE** button to display the **Admin** soft key option. If you access phone administration during a call, only the **SPEAKER**, **MUTE** and **HEADSET** buttons still affect the connected call.
2. Use the  up or down  arrow buttons to scroll to **Telephone Programming**. Press **Select**.
3. Use the  up or down  arrow buttons to scroll the display to **DND Exceptions**. When shown, press **Select**.
4. The current entries are displayed. Use the  up or down  arrow buttons to scroll through the list of numbers.
 - To delete the currently displayed number press **Delete**.
 - To add a new number start dialing or press **Add**. Dial the number and click **Save**.
 - To add a wildcard, press the button for the highlighted row and select **Dial X** (single digit wildcard) or **Dial N** (multiple digits wildcard) and then press **Back**.
- Exit phone administration by pressing the  **PHONE** button. Alternatively use the **Back** button to move to another menu.

Chapter 4.

Using Voicemail

4. Using Voicemail

The telephone system includes embedded voicemail and each extension on the system has a voicemail mailbox by default. The message lamp on your phone is lit when you have new messages in your mailbox.

Except for special cases, for example the extensions connected to the fax machine and loudspeaker, the mailboxes are used when the extension has calls it does not answer within a set time (by default 15 seconds though this can be adjusted for each extension by the system administrator).

Your system administrator can also configure other methods of access including access to your mailbox from other phones.

- **Embedded Voicemail User Guide**

The embedded voicemail system can operate two different ways, each of which uses different key presses once you have logged in to a mailbox. The modes are Intuity emulation mailbox mode and IP Office mailbox mode. Your system administrator will inform you which mode your system is using and provide the appropriate embedded voicemail user guide for that mode.

Accessing Your Mailbox

1. Press an idle intercom or call appearance button and dial **777**.
 - To access your mailbox from another extension, dial **778** and enter your own extension number when asked which mailbox you want to access.
2. If your mailbox has an access code set, you will be prompted to enter it. Enter your access code and press #.
3. You will hear a prompt telling you how many messages you have. If you have any new messages the voicemail system will start playing your new messages.

IMPORTANT

Once a new message has been listened to, it is marked as 'old' and is automatically deleted after 24 hours. If you do not want the message deleted, you must mark it as 'saved' by pressing **5** while listening to the message.

4.1 Voicemail Coverage On/Off



Calls to your extension can be rerouted to your voicemail mailbox if you do not answer the call within a set number of rings, the default being 3 rings. This is called VMS Cover. The number of rings used for your extension is set by your system administrator.

- If an extension has [Call Coverage](#) ^[32] and VMS Cover active, a covered calls ring at the covered extension for the specified number of Call Coverage Rings. It will then start ringing the covering extension. If the covering extension does not answer, the call is routed to the voice mailbox of the extension that activated Call Coverage after the specified number of VMS Cover Rings. The count of VMS cover rings starts when the covered extension initially begins to ring. If the covering extension has [Do Not Disturb](#) ^[36] active, the call is routed immediately to the voice mailbox of the extension that activated Call Coverage.
- Users with VMS Cover turned on can activate [Do Not Disturb](#) ^[36] to send ringing calls immediately to their voice mailbox.
- Note that when your voicemail cover is off, you can still access the messages in your mailbox and other users can still use forwarding to send messages to your mailbox.



To create a VMS cover button

1. Press the **Admin** soft key on the display.



- During a call, press the  **PHONE** button to display the **Admin** soft key option. If you access phone administration during a call, only the **SPEAKER**, **MUTE** and **HEADSET** buttons still affect the connected call.

2. Use the  up or down  arrow buttons to scroll to **Telephone Programming**. Press **Select**.

3. Press the programmable button you want to change. Alternatively:

- Use the  up or down  arrows to scroll to **Button Programming**. Press **Select**.
- At the **Button:** prompt press the button to edit or enter from the button number.

4. The current setting of that button is displayed.

3. Press **Program** and either dial **#15** or use the  up or down  arrow buttons to scroll the display to **VMS Cover** and press **Select**.

4. The current setting of the button will now be set to **VMS Cover**.

- Exit phone administration by pressing the  **PHONE** button. Alternatively use the **Back** button to move to another menu.



Chapter 5.

Contacts

5. Contacts





The contacts directory contains system directory number, systems users and hunt groups and your own personal contacts.

This menu is accessed by pressing the  key. It is used to display names and numbers that you can then use for making calls.



The directory includes names stored for use by all users, names stored for use by just you and the name and numbers of all the other users and groups on the phone system.

5.1 Viewing Contacts Details







1. Access the contacts directory:

- a. Press the  **CONTACTS** key. The directory menu is displayed.
- b. Use the  left and right  arrow keys to select which type of directory entries you want displayed.
 - **All**
All directory entries.
 - **Personal**
Your personal speed dials.
 - **External**
The system speed dials.
 - **Users**
The names and numbers of other users on the telephone system.
 - **Groups**
The names and numbers of hunt groups on the telephone system.
- c. Either press the **List** soft key to display all the directory entries or start dialing the name to display only matching entries.
- d. Use the  up and down  arrow keys to scroll through the matching entries. To return to the start to match a different directory selection, press the **Clear** soft key.

2. When the required entry is displayed, press **Details** to display the name and number.





3. Use the  up and down  arrow key to switch between the name and the number.

4. The range of soft keys available will depend on the type of directory entry:

- **Call**  
Make a call to the stored number.
- **Back**
Go back to the directory listing.
- **More**
If the contact is one of your personal directory entries, the **More** soft key will be present to allow you to access the options below. It is also present for external directory entries if you are a system administrator (either of the first two extensions on the system).
- **Edit**  
Edit the name and number.
- **Delete**  
Delete the name and number.







5.2 Make a Call from the Directory

You can use any directory contacts to make a call. You can also use the directory in almost any telephone function where you need to select the number for a destination, for example during transfers.

- On a key mode system, to call an internal number, you need to press an **Intercom** button before selecting the number from the directory.
1. Access the contacts directory:
 - a. Press the  **CONTACTS** key. The directory menu is displayed.
 - b. Use the  left and right  arrow keys to select which type of directory entries you want displayed.
 - **All**
All directory entries.
 - **Personal**
Your personal speed dials.
 - **External**
The system speed dials.
 - **Users**
The names and numbers of other users on the telephone system.
 - **Groups**
The names and numbers of hunt groups on the telephone system.
 - c. Either press the **List** soft key to display all the directory entries or start dialing the name to display only matching entries.
 - d. Use the  up and down  arrow keys to scroll through the matching entries. To return to the start to match a different directory selection, press the **Clear** soft key.
 2. When the required entry is displayed, press **Call**.
 3. Continue as for a normally dialed call.





5.3 Editing a Contact

You can edit the contacts in your own personal directory.

1. Access your personal directory contacts:
 - a. Press the  **CONTACTS** key. The directory menu is displayed.
 - b. Use the  left and right  arrow keys to select your **Personal** directory. The first two extensions on the system can also add, edit and delete entries from the **External** directory.
 - c. Either press the **List** soft key to display all the directory entries or start dialing the name to display only matching entries.
 - d. Use the  up and down  arrow keys to scroll through the matching entries. To return to the start to match a different directory selection, press the **Clear** soft key.
2. Locate the required entry.
3. Press the **Details** soft key.
4. Press the **More** soft key and then the **Edit** soft key.
 - The menu now allows editing of the name and number.
 - Use the  up and down  arrow keys to switch between number and name entry.
 - When the name has been entered as required, press the **OK** soft key.
 - When the number has been entered as required, press the **Save** soft key.
 - To exit without making any changes, press the **Cancel** soft key.





5.4 Adding a New Contact

So long as the telephone system capacity has not been reached, you can add up to 100 personal directory entries.

1. Access your personal directory contacts:
 - a. Press the  **CONTACTS** key. The directory menu is displayed.
 - b. Use the  left and right  arrow keys to select your **Personal** directory. The first two extensions on the system can also add, edit and delete entries from the **External** directory.
2. Press the **New** soft key.
 - The menu now allows editing of the name and number.
 - Use the  up and down  arrow keys to switch between number and name entry.
 - When the name has been entered as required, press the **OK** soft key.
 - When the number has been entered as required, press the **Save** soft key.
 - To exit without making any changes, press the **Cancel** soft key.





5.4.1 Add a Contact from the Call Log

You can add a name and number shown in your call log to your personal speed dials. You can only do this if there is space in your allowed 20 personal speed dials.

1. Access the call log.
 - a. Press the  **CALL LOG** or **HISTORY** button.
 - b. The display will change to show your call log records. The caller's name is shown if known, otherwise the number.
 - c. Use the  up and down  arrow keys to scroll through the records.
2. Press the **Details** soft key. The individual details of the currently selected call record are displayed.
3. Press the **+Contact** soft key.
4. Use the  up and down  arrow keys to switch between the name and number details for the new contact.
5. Using the telephone keypad and the **Bksp** soft key you can edit the name and the number. When editing the number, use the **Pause** soft key to enter a comma (,) for a 1 second pause in the number dialing.
6. When the name and number are set as required, press the **Save** soft key. To return without saving the name and number, press the **Cancel** soft key.

5.5 Deleting a Contact

You can delete a personal speed dial from your contacts.

1. Access your personal directory contacts:
 - a. Press the  **CONTACTS** key. The directory menu is displayed.
 - b. Use the  left and right  arrow keys to select your **Personal** directory. The first two extensions on the system can also add, edit and delete entries from the **External** directory.
 - c. Either press the **List** soft key to display all the directory entries or start dialing the name to display only matching entries.
 - d. Use the  up and down  arrow keys to scroll through the matching entries. To return to the start to match a different directory selection, press the **Clear** soft key.
2. Locate the required entry.
3. Press the **Details** soft key.
4. Press the **More** soft key and then the **Delete** soft key.

Chapter 6.

Call Log

6. Call Log

This menu is accessed by pressing the  **CALL LOG** or **HISTORY** key.

- [Making a Call](#) ^[48]
- [Viewing Call Details](#) ^[49]
- [Deleting a Record](#) ^[50]
- [Deleting All Records](#) ^[50]
- [Add a Record to Your Contacts](#) ^[50]

6.1 Using the Call Log

1. Access the call log.

- Press the  **CALL LOG** or **HISTORY** button.
- The display will change to show your call log records. The caller's name is shown if known, otherwise the number.
- Use the ▲ up and down ▼ arrow keys to scroll through the records.

2. Pressing **OK** will make a call to the number stored with the currently displayed record.

3. You can use the functions listed at the bottom of the display by pressing the soft key below the function name.

- [Call](#) ^[48]
Make a call to the number stored in the currently displayed call log record.
- [Details](#) ^[49]
Display more details about the current call log record. You can then also [add the caller details to your personal directory](#) ^[50] if required.
- **More**
Switch between the different sets of available soft key functions.
- [Delete](#) ^[50]
Deletes the current displayed record.
- [Del All](#) ^[50]
Delete all the call log records, not just the current types of records being shown.

4. To exit the call log, press the **PHONE/EXIT** button.

6.2 Making a Call from the Call Log

You can use the call log to make calls to the number included in the currently selected call record.





1. Access the call log.

- Press the  **CALL LOG** or **HISTORY** button.
- The display will change to show your call log records. The caller's name is shown if known, otherwise the number.
- Use the ▲ up and down ▼ arrow keys to scroll through the records.

2. Press the **Call** soft key or **OK** to call the number displayed in the call record.



6.3 Viewing Call Details

You can view additional details about the currently shown call.

1. Access the call log.
 - a. Press the  **CALL LOG** or **HISTORY** button.
 - b. The display will change to show your call log records. The caller's name is shown if known, otherwise the number.
 - c. Use the  up and down  arrow keys to scroll through the records.
2. Press the **Details** soft key. The individual details of the currently selected call record are displayed.
3. Use the  up and down  arrow keys to scroll through the details. The possible values are:
 - **Time**
The time of the call.
 - **Ring Time**
For missed calls, the duration of ringing is included in the call details.
 - **Duration**
The length of the call.
 - **Name**
The name of the caller if known.
 - **Number**
The number of the caller if available.
 - **Reason**
The type of call record, ie. **Answered**, **Outgoing** or **Missed**. For missed calls, the reason may be indicated, for example:
 - Missed: Lost - Indicates a call where the caller hung up before they could be answered.
 - Missed: Voicemail - Indicates a call where the caller was redirected to voicemail.
 - **Count**
How many time a call of the same type, name and number has occurred. Only the details of the most recent call are kept in your call log. However, the count will indicate if the caller has rung or has been rung several times.
4. While you are in the details of a call record, the soft key functions available are:
 - **Call**
Call the number shown in the call record. You can also do this by pressing the **OK** button.
 - **+Contact**
Add the name and number to your personal directory. You can edit the details before they are added.
 - **Back**
Go back to the normal call screen to select another call record.



6.4 Deleting a Record

You can delete the currently displayed call record.

1. Access the call log.
 - a. Press the  **CALL LOG** or **HISTORY** button.
 - b. The display will change to show your call log records. The caller's name is shown if known, otherwise the number.
 - c. Use the  up and down  arrow keys to scroll through the records.
2. Press the **More** soft key.
3. Press the **Delete** soft key to delete the currently displayed call log record.





6.5 Deleting All Records

You can delete all call records from your call log.

1. Access the call log.
 - a. Press the  **CALL LOG** or **HISTORY** button.
 - b. The display will change to show your call log records. The caller's name is shown if known, otherwise the number.
 - c. Use the  up and down  arrow keys to scroll through the records.
2. Press the **More** soft key.
3. Press the **Del All** soft key to delete all your call log records.

6.6 Adding a Record to Your Contacts

You can add a name and number shown in your call log to your personal speed dials. You can only do this if there is space in your allowed 20 personal speed dials.

1. Access the call log.
 - a. Press the  **CALL LOG** or **HISTORY** button.
 - b. The display will change to show your call log records. The caller's name is shown if known, otherwise the number.
 - c. Use the  up and down  arrow keys to scroll through the records.
2. Press the **Details** soft key. The individual details of the currently selected call record are displayed.
3. Press the **+Contact** soft key.
4. Use the  up and down  arrow keys to switch between the name and number details for the new contact.
5. Using the telephone keypad and the **Bksp** soft key you can edit the name and the number. When editing the number, use the **Pause** soft key to enter a comma (,) for a 1 second pause in the number dialing.
6. When the name and number are set as required, press the **Save** soft key. To return without saving the name and number, press the **Cancel** soft key.

Chapter 7.

Button Programming

7. Button Programming

You can assign functions to the programmable buttons on your phone. However, you cannot override any **Intercom**, **Call Appearance** or **Line Appearance** buttons assigned by the system and your system maintainer.



7.1 Programming a Button

Use the following process to set or change the function of a button.



- You cannot override any **Intercom**, **Call Appearance** or **Line Appearance** buttons assigned by the system and your system maintainer.
- Some functions are unique, ie. if already assigned to a button, assigning the function to another button will automatically clear the setting from the existing button.

1. Press the **Admin** soft key on the display.



- During a call, press the  **PHONE** button to display the **Admin** soft key option. If you access phone administration during a call, only the  **SPEAKER**,  **MUTE** and  **HEADSET** buttons still affect the connected call.

2. Use the  up or down  arrow buttons to scroll to **Telephone Programming**. Press **Select**.

3. Press the programmable button you want to change. Alternatively:

- Use the  up or down  arrows to scroll to **Button Programming**. Press **Select**.
- At the **Button:** prompt press the button to edit or enter from the button number.

4. The current setting of that button is displayed.

- To remove the function, press **Clear**.
- To change the function, press **Program**.
- Use the  up and down  arrow buttons to scroll through the menu options and select the required [button function](#) ⁵⁴.



5. You can add a text label to buttons which have a feature assigned. The label will replace the default label shown otherwise.

a. Press **Label**.

b. Enter a label for the button using the controls and when complete press **Save**.

- Enter a character by pressing the indicated button until that character is displayed. Accented versions of the characters are also shown. If you pause more than 1 second after press a button, the cursor will move onto the next space.

1	1.,@	2	abc2	3	def3
4	ghi4	5	jkl5	6	mno6
7	pqrs7	8	tuv8	9	wxyz9
*	*	0	Space 0	#	#



- The first character and the first character after a space are automatically capitalized.
- Use the  left and right  arrows keys to move the cursor. Press **Bksp** to delete the character before the cursor.
- Exit phone administration by pressing the  **PHONE** button. Alternatively use the **Back** button to move to another menu.

7.2 Changing a Button Label



The default text label shown for a button depends on the function assigned to that button. You can override this by applying your own text label.

1. Press the **Admin** soft key on the display.

- During a call, press the  **PHONE** button to display the **Admin** soft key option. If you access phone administration during a call, only the  **SPEAKER**,  **MUTE** and  **HEADSET** buttons still affect the connected call.

2. Use the  up or down  arrow buttons to scroll to **Telephone Programming**. Press **Select**.

3. Press the programmable button you want to change. Alternatively:

- Use the  up or down  arrows to scroll to **Button Programming**. Press **Select**.
- At the **Button:** prompt press the button to edit or enter from the button number.



4. The current setting of that button is displayed.

a. Press **Label**.

b. Change the label for the button using the controls and when complete press **Save**.

- Enter a character by pressing the indicated button until that character is displayed. Accented versions of the characters are also shown. If you pause more than 1 second after press a button, the cursor will move onto the next space.

1	1.,@	2	abc2	3	def3
4	ghi4	5	jkl5	6	mno6
7	pqrs7	8	tuv8	9	wxyz9
*	*	0	Space 0	#	#

- The first character and the first character after a space are automatically capitalized.
- Use the  left and right  arrows keys to move the cursor. Press **Bksp** to delete the character before the cursor.
- Exit phone administration by pressing the  **PHONE** button. Alternatively use the **Back** button to move to another menu.

7.3 Button Functions

You can [assign](#) ⁵² the following functions to programmable buttons on your phone.

Function	Description
Absent Message	This function allows you to set or clear an absent message for display on your phone. When set, the absent message is also displayed on other extensions when they call the user.
Account Code Entry	This function allows you to enter an account code prior to making a call or during a call.
Active Line Pickup	This function allows you to answer a call on a particular line. It can be used if the call is ringing, held or already answered by another extension.
Auto Dial Intercom	This function allows you to make a call to another specified extension. The button lamp will also indicate when that other extension is in use.
Auto Dial Other	This function allows you to make a call using a number stored with the button. The number can be an internal number, an external number, an account code or any other number. The button can then be used when a number of that type needs to be dialed.
Call Coverage	This function allows you to switch call coverage on or off. When on, any calls to you that ring unanswered also start ringing at your call coverage extension.
Caller ID Log	This function allows you to view the phone system's call log of all caller IDs of calls received by the system. To use this you must be one of the three extensions configured for call ID logging by your system administrator.
Call Forwarding	This function allows you to redirect all your calls to another number. If the system administrator has configured you for Remote Call Forwarding, you can forward calls externally by specifying a personal speed dial as the destination.
Call Pickup	This function allows you to pickup a call alerting at a specified extension. Separate buttons can be created for each extension for which call pickup is required.
Call Screening	This function allows you to switch call screening on or off. When on, if your phone is idle, when a call rings it and then goes to voicemail you will hear the caller through the phone's handsfree speaker. You can choose to ignore the call (press Ignore on the display) or to answer it (press Answer on the display). This button function can only be set by your system administrator.
Caller ID Inspect	This function allows you to see the caller ID of a call on another line without interrupting the current call to which you are connected.
Caller ID Name	This function allows you to swap the display of caller ID name and number information on the phone.
Calling Group	This function allows you to call or page the calling group represented by the button.
Conference Drop	This function allows you to select and drop a call from a conference.
Contact Closure	This function you to operate the system's contact closure 1 or 2 connection. To use this you must be a member of the system's contact closure group.
Do Not Disturb	This function allows you to switch do not disturb on or off.
Hot Dial	This function allows you to dial a stored number without first going off hook or pressing the SPEAKER button.
Hunt Group	This function allows you to call or page the hunt group represented by the button.
Idle Line Pickup	This function allows the user to seize a line if that line is idle. This allows the user to access line for which they do not have a line appearance button on their extension.
Last Number Redial	This function allows you to redial the last external number dialed.
Message Alert Notification	This function allows you to see the current state of other user's message waiting lamps. It is used in conjunction with other users for which you have Auto Dial - Intercom buttons.
Night Service	A night service button is used to switch night service on/off. It can only be used on the first extension in the system.
Pickup Group	This function allows you to answer a call being presented to any extension that is a member of the pickup group (1 to 4) configured for the button.

Privacy	This function allows you to turn privacy on or off. When on, other extensions are not able to bridge into your calls.
Recall	This function allows you to send a recall or hook flash signal.
Saved Number Redial	This function allows you to save the number dialed during a call and to redial that number when idle. This can be used when the number dialed does not answer.
Station Lock	This function allows you to lock and unlock your extension from being used to make calls. When selected, you are prompted to enter a four digit code after which the extension is locked. If the extension is already locked, use of this function prompts for reentry of the four digit code to unlock the extension.
Station Unlock	This function can only be used by the first two extensions in the system. It allows the user to unlock any extension without needing to know the code that was used to lock that extension.
VMS Cover	This function allows the you to switch use of voicemail coverage for your extension on or off.
Voice Mailbox Transfer	This function allows you to transfer your current call to another extension's mailbox. Your current call is put on hold and you enter the target extension number to indicate the mailbox required.
Wake Up Service	A Wake Up Service button can be assigned for the first extension on the system. Using this button, the extension user can set wake up calls within the next 24-hours period for any other extension.

Function Status Indication

For some functions, for example those that can be on or off, the icon or LED in the programmable button will indicate the current status of the function.

To activate and deactivate one of the following features using a programmable feature button, press the button and follow the onscreen prompts. During feature activation and deactivation, the status LED on the associated programmable feature button does not reflect the current state of the feature. However, upon exiting the feature activation/deactivation screen, the new state of the feature is shown by the programmable button's status LED.

- Absent Message
- Account Code Entry
- Call Log
- Wake Up Service Button
- Station Lock
- Station Unlock
- Night Service (when a system password has been administered)
- Caller ID Inspect

Chapter 8.

Phone Settings

8. Phone Settings



8.1 Naming Your Extension

You can assign a name to your extension, up to 20 characters long. The name is then displayed on the phone and also on other extensions when you make or receive calls.

To change your extension name

1. Press the **Admin** soft key on the display.

- During a call, press the  **PHONE** button to display the **Admin** soft key option. If you access phone administration during a call, only the **SPEAKER**, **MUTE** and **HEADSET** buttons still affect the connected call.

2. Use the  up or down  arrow buttons to scroll to **Telephone Programming**. Press **Select**.



3. Use the  up or down  arrow buttons to scroll the display to **Extension Name**. When displayed, press **Select**.

4. The current setting is displayed. To remove the current name, press **Clear**.

5. To enter a new name, press **Enter** and dial the characters using the dial pad buttons. When finished press **OK**.

- Enter a character by pressing the indicated button until that character is displayed. Accented versions of the characters are also shown. If you pause more than 1 second after press a button, the cursor will move onto the next space.

1	1.,@	2	abc2	3	def3
4	ghi4	5	jkl5	6	mno6
7	pqrs7	8	tuv8	9	wxyz9
*	*	0	Space 0	#	#

- The first character and the first character after a space are automatically capitalized.
- Use the  left and right  arrows keys to move the cursor. Press **Bksp** to delete the character before the cursor.
- Do not use punctuation characters such as #, ?, /, -, _ and , in the name. Start the name with an alphabetic character. Note that the name is case sensitive and must be unique. Non-English languages do not offer accented characters.
- Exit phone administration by pressing the  **PHONE** button. Alternatively use the **Back** button to move to another menu.

8.2 Visual Alerting

The message waiting lamp at the top-right corner of the phone can also be used to indicate when you have a call alerting your phone. The lamp is flashed to indicate a call waiting to be answered.

1. Press the **A MENU** button.
2. Use the ▲ up and down ▼ arrow keys to locate the option **Call Settings...** Press the **Select** soft key.
3. Use the ▲ up and down ▼ arrow keys to locate the option **Visual Alerting**.
4. Use the ◀ left and right ▶ arrow keys or press the **On/Off** soft key to change the setting.
5. When completed, press the **Done** soft key.
6. Press the **Exit** soft key to exit the menus.

8.3 Audible Alerting

The phone's audible ringer can be switched off. This only affects the ring and does not affect the [visual alerting](#) ⁵⁹.

1. Press the **A MENU** button.
2. Use the ▲ up and down ▼ arrow keys to locate the option **Call Settings...**
3. Press the **Select** soft key.
4. Use the ▲ up and down ▼ arrow keys to locate the option **Audible Alerting**.
5. Use the ◀ left and right ▶ arrow keys or press the **On/Off** soft key to change the setting.
6. When completed, press the **Done** soft key.
7. Press the **Exit** soft key to exit the menus.

8.4 Ringer Sound

You can adjust the sound of the ring used by the phone.

1. Press the **A MENU** button.
2. Use the ▲ up and down ▼ arrow keys to locate **Screen/Sounds** or **Screen & Sound Options**. Press the **Select** soft key.
3. Use the ▲ up and down ▼ arrow keys to locate the option **Personalized Ringing**. Press the **Select** soft key.
 - Use the ▲ up and down ▼ arrow keys to scroll through the different available ring patterns.
 - Press the **Play** soft key to repeat the currently display ring pattern.
 - To make the currently displayed ring pattern the selected ring pattern for the phone press the **Save** soft key.
 - To leave the menu without making any changes press the **Cancel** soft key.
4. When completed, press the **Done** soft key.
5. Press the **Exit** soft key to exit the menus.

8.5 Ringer Volume

When the phone is not on any calls, you can adjust the volume used for the ringer.

1. With the phone idle, use the ▲ up arrow and ▼ down arrow keys to change the volume.

8.6 Display Brightness

1. Press the **A MENU** button.
2. Use the ▲ up and down ▼ arrow keys to locate **Screen/Sounds** or **Screen & Sound Options**. Press the **Select** soft key.
3. Use the ▲ up and down ▼ arrow keys to locate **Brightness**. Press the **Select** soft key.
4. Use the ◀ left and right ▶ arrow keys to adjust the brightness as required.
5. When completed, press the **Done** soft key.
6. Press the **Exit** soft key to exit the menus.

8.7 Display Contrast

1. Press the **A MENU** button.
2. Use the ▲ up and down ▼ arrow keys to locate **Screen/Sounds** or **Screen & Sound Options**. Press the **Select** soft key.
3. Use the ▲ up and down ▼ arrow keys to locate the option **Contrast**. Press the **Select** soft key.
4. Use the ◀ left and right ▶ arrow keys to adjust the brightness as required.
5. When completed, press the **Done** soft key.
6. Press the **Exit** soft key to exit the menus.

8.8 Display Language

The system administrator can configure which language your extension uses. Though the phone's menu you can change that setting.

IP Office Basic Edition - IP Office Basic Edition - Norstar Mode supports a number of languages. The phone menu may display other languages also supported by the phone. If one of these other languages is selected, the languages displayed on the phone menu may be a mix of that language and English.

1. Press the **A MENU** button.
2. Use the ▲ up and down ▼ arrow keys to locate the option **Advanced**. Press the **Select** soft key.
3. Use the ▲ up and down ▼ arrow keys to locate the option **Language**. Press the **Select** soft key.
4. Use the ▲ up and down ▼ arrow keys scroll through the different languages available.
5. To select the language currently displayed, press the **Select** soft key or **OK**.
6. When completed, press the **Done** soft key.
7. Press the **Exit** soft key to exit the menus.

8.9 Error Tones

1. Press the **A MENU** button.
2. Use the **▲** up and down **▼** arrow keys to locate **Screen/Sounds** or **Screen & Sound Options**. Press the **Select** soft key.
3. Use the **▲** up and down **▼** arrow keys to locate the option **Error Tone**.
4. Use the **◀** left and right **▶** arrow keys or press the **On/Off** soft key to change the setting.
5. When completed, press the **Done** soft key.
6. Press the **Exit** soft key to exit the menus.

8.10 Button Clicks

While using the phone menus, the phone can provide a key press confirmation click sound. This can be turned off if it is annoying.

1. Press the **A MENU** button.
2. Use the **▲** up and down **▼** arrow keys to locate **Screen/Sounds** or **Screen & Sound Options**. Press the **Select** soft key.
3. Use the **▲** up and down **▼** arrow keys to locate the option **Button Clicks**.
4. Use the **◀** left and right **▶** arrow keys or press the **On/Off** soft key to change the setting.
5. When completed, press the **Done** soft key.
6. Press the **Exit** soft key to exit the menus.

8.11 Default Handsfree Audio Path

By default, when you make a call or answer a call without lifting the handset, the audio is played through the phone's speaker while you speak via the phone's microphone.

If you have a headset attached, you can change the phone's behavior so the audio is played through the headset by default rather than the speaker.

1. Press the **A MENU** button.
2. Use the **▲** up and down **▼** arrow keys to locate the option **Call Settings....** Press the **Select** soft key.
3. Use the **▲** up and down **▼** arrow keys to locate the option **Audio Path**.
4. Use the **◀** left and right **▶** arrow keys or press the **Change** soft key to change the setting.
5. When completed, press the **Done** soft key.
6. Press the **Exit** soft key to exit the menus.

8.12 The Admin Menu

The **Admin** option is used to access a series of menus for phone based administration.

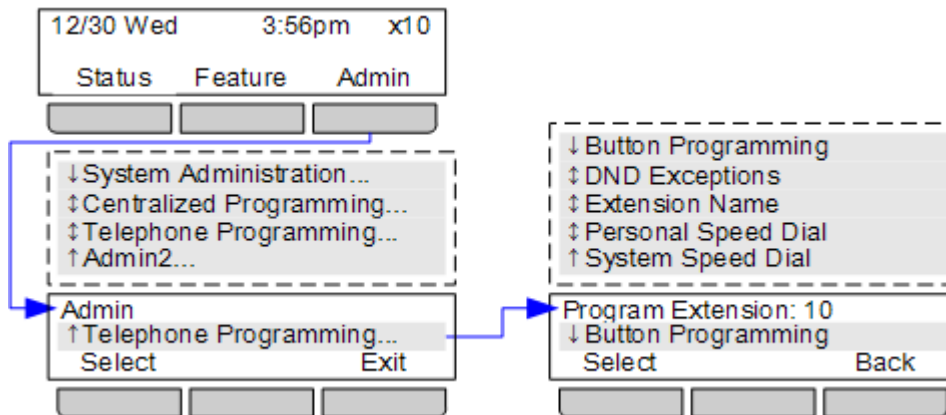

1. Press the **Admin** soft key on the display.

- During a call, press the **PHONE** button to display the **Admin** soft key option. If you access phone administration during a call, only the **SPEAKER**, **MUTE** and **HEADSET** buttons still affect the connected call.

2. Use the up or down arrow buttons to scroll to **Telephone Programming**. Press **Select**.

- For the first two extensions on the system, a range of options are selectable. The use of those options is covered by the IP Office Basic Edition - Norstar Mode Phone Based Administration manual.

3. Use the up and down arrow buttons to scroll through the menu options.

- **Button Programming** This menu allows you to assign functions to the programmable buttons on your phone. You cannot override any **Intercom**, **Call Appearance** or **Line Appearance** buttons assigned by the system and your system maintainer.
- **DND Exceptions** Set numbers with can still call you even when you have do not disturb on.
- **Extension Name** Set your extension name. This is shown on your phone and on others when they call you or are called by you.
- **Personal Speed Dial** Create and edit your personal speed dials.
- **System Speed Dial** This option is only shown on the first two extensions in the system. It allows those extension users to create and edit system speed dials for use by all users.
- Exit phone administration by pressing the **PHONE** button. Alternatively use the **Back** button to move to another menu.

8.13 The A MENU

The **A MENU** key is used to access a range of phone settings. These are mainly settings held by the phone, not the phone system.

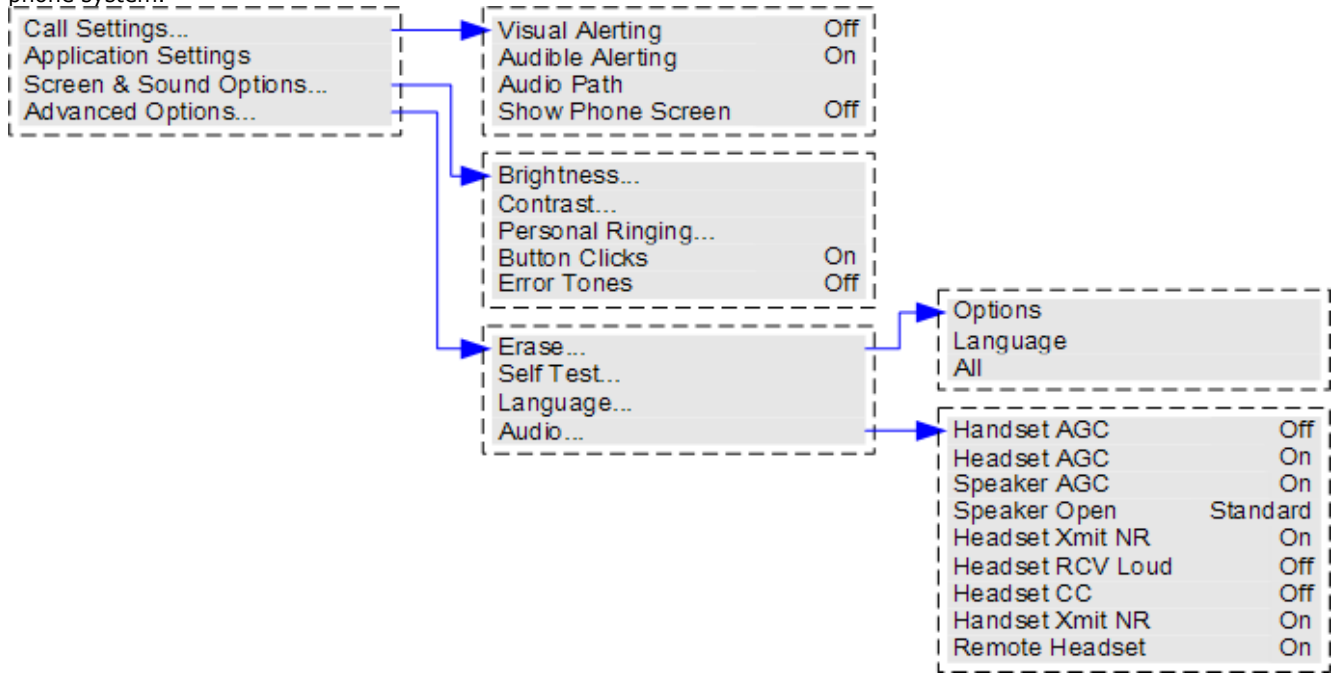

8.14 A-Menu Auto Exit

The **Show Phone Screen** option only applies to the A-menu screens accessed when you press the **A** key. If the option is on, if you receive a call while in the A-menu, the phone will automatically exit the menus and display the call details.

1. Press the **A MENU** button.
2. Use the ▲ up and down ▼ arrow keys to locate the option **Call Settings...** Press the **Select** soft key.
3. Use the ▲ up and down ▼ arrow keys to locate the option **Show Phone Screen**.
4. Use the ◀ left and right ▶ arrow keys or press the **On/Off** soft key to change the setting.
5. When completed, press the **Done** soft key.
6. Press the **Exit** soft key to exit the menus.

Index

A

Absent Text Message 30
 Account Code 35
 Add
 Contact 46, 50
 Alert Notification 54
 All
 Call Log 46, 48, 49, 50
 Contacts 44, 45
 Answer a Call 17
 Answered 46, 48, 49, 50
 At home 30
 At lunch until 30
 Audible Alerting 59
 Audio Path 61
 Auto Dial 21
 Away from desk 30

B

Back soon 30
 Back tomorrow 30
 Be right back 30
 Bridge 27
 Button
 Call Screening 54
 Message Alert Notification 54

C

Call
 Bridge 27
 Coverage 32
 Forward 31
 from Call Log 48
 from Contacts 45
 Ignore 17
 Join 27
 Park 23
 Pickup 17
 To VM 17
 CALL LOG 46, 48, 49, 50
 Call from 48
 Details 49
 Menu 48
 Call Screening 54
 Call Settings
 Audible alerting on/off 59
 Audio Path 61
 Visual alerting on/off 59
 Call Transfer - Supervised 24
 Call Transfer - Unsupervised 24
 Callback 14
 Caller
 Details 49
 Caller volume 22
 Code
 Account 35
 Lock 34
 Conference
 Hold 25
 Start 25
 Contact
 Add 46, 50
 Edit 45, 46
 CONTACTS 44, 45, 46
 Make call 45

Count 49
 Coverage
 Call 32
 Voicemail 41

D

Details
 Call Log 49
 Directory
 Add 46, 50
 Edit 45, 46
 Make call 45
 Do Not Disturb 30, 36
 Don't disturb until 30

E

Edit
 Contact 45, 46
 Exceptions 37
 Extension
 Name 58
 External 44, 45

F

Forward 31

G

Group
 Call log 48
 Missed 48
 Groups 44, 45

H

Handset volume 22
 Handsfree 26
 Hold
 Conference 25
 Hold a Call 23
 Hunt group
 Call log 48
 Missed 48

I

Ignore 17

J

Joining a Call 27

L

Lamp 59
 Lock 34

M

Make call
 from Call Log 48
 from Contacts 45
 Meeting until 30
 Menu
 Call log 48
 Contacts 44
 Message Alert Notification 54
 Message waiting lamp 59
 Missed 46, 48, 49, 50
 Missed calls
 Hunt group calls 48
 More 48

N

Name 58
 New
 Contact 46, 50
 Notification 54

O

On holiday until 30
On vacation 30
Out to lunch 30
Outgoing 46, 48, 49, 50

P

Parking Calls 23
Personal Speed Dial 20
Personal 44, 45
Please call 30

R

Reason 49
Ring Again 14
Ring Back 14
Ring Time 49
Ringer
 Audible alerting on/off 59
Ringer volume 22

S

Screening 54
Speaker volume 22
Speakerphone 26
Speed Dial
 Personal 20
 System 19
Supervised Call Transfer 24
System Speed Dial 19

T

To VM 17
Transfer
 To Voicemail 24
Transfer a Call 24

U

Unlock 34
Unsupervised Call Transfer 24
Users 44, 45

V

Visual Alerting 59
Voicemail
 Coverage 41
 Transfer 24
Volume 22

W

Wake Up Service 54
With Cust. until 30
With visitors until 30

Performance figures and data quoted in this document are typical, and must be specifically confirmed in writing by Avaya before they become applicable to any particular order or contract. The company reserves the right to make alterations or amendments to the detailed specifications at its discretion. The publication of information in this document does not imply freedom from patent or other protective rights of Avaya or others.

All trademarks identified by the ® or ™ are registered trademarks or trademarks, respectively, of Avaya Inc. All other trademarks are the property of their respective owners.

This document contains proprietary information of Avaya and is not to be disclosed or used except in accordance with applicable agreements.

© 2011 Avaya Inc. All rights reserved.